

c.Arboga I 40 (280x280)

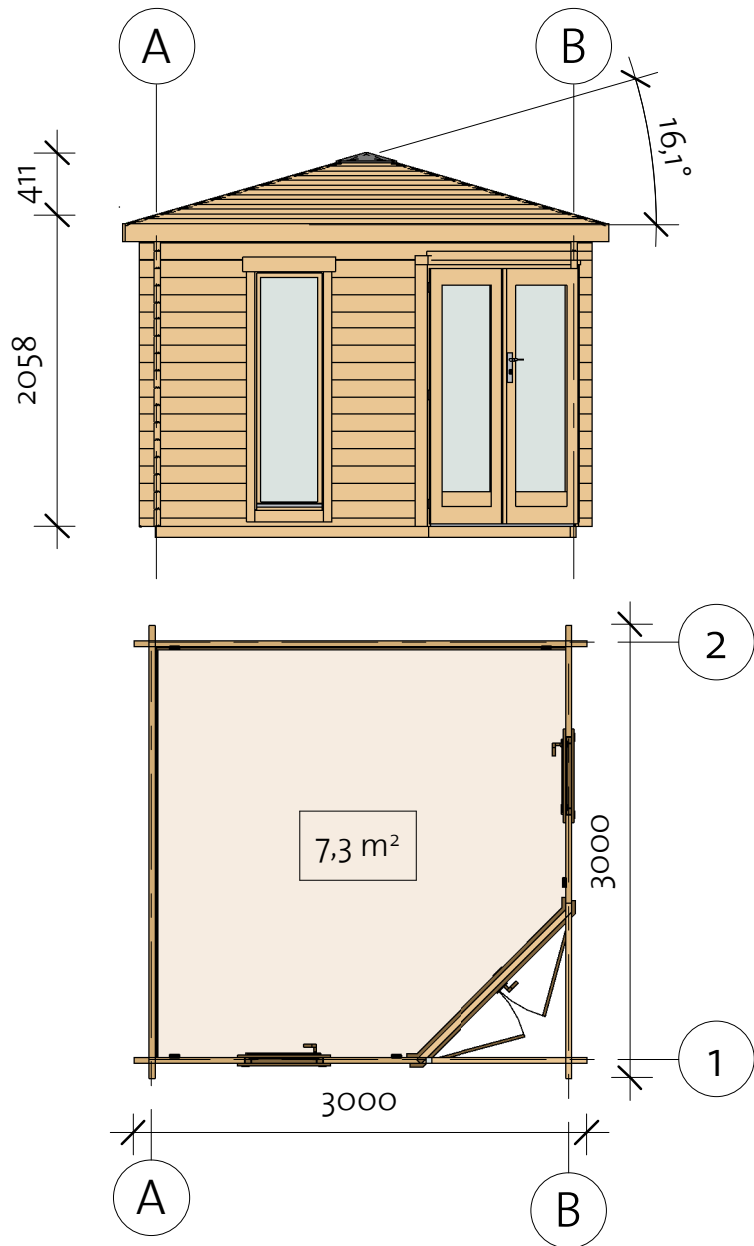

c.Arboga I 40 (280x280)

Foundation

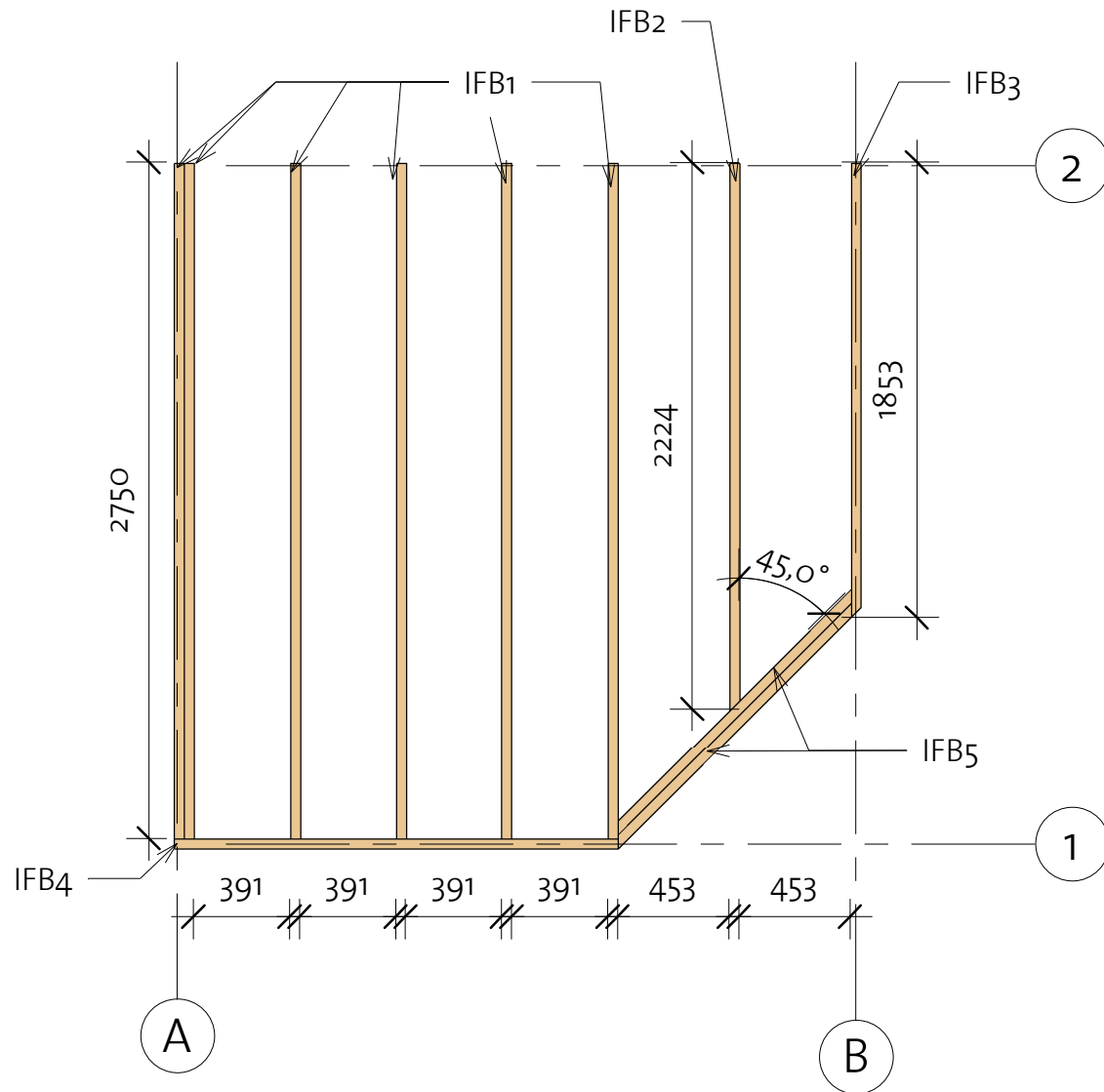

Impregnated foundation beams

Mark	Type	Profile	Count	Length
IFB1	IFB 40x70		6	2750
IFB2	IFB 40x70		1	2224
IFB3	IFB 40x70		1	1845
IFB4	IFB 40x70		1	1805
IFB5	IFB 40x70		2	1376

c.Arboga I 40 (280x280)

Floor Plan

① Baseboard

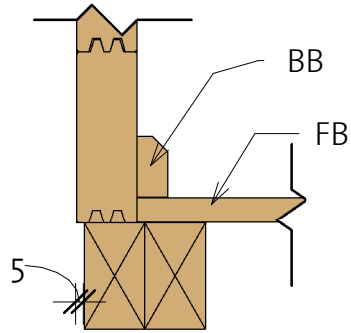

Floor Schedule

Mark	Type	Profile	Count	Length
FB1	FB 17x114		1	1847
FB2	FB 17x114		1	1961
FB3	FB 17x114		1	2075
FB4	FB 17x114		1	2189
FB5	FB 17x114		1	2303
FB6	FB 17x114		1	2417
FB7	FB 17x114		1	2531
FB8	FB 17x114		1	2645
FB9	FB 17x114		1	2717
FB10	FB 17x114		16	2717

BB1	BB 20x40		4	2800
-----	-------------	---	---	------

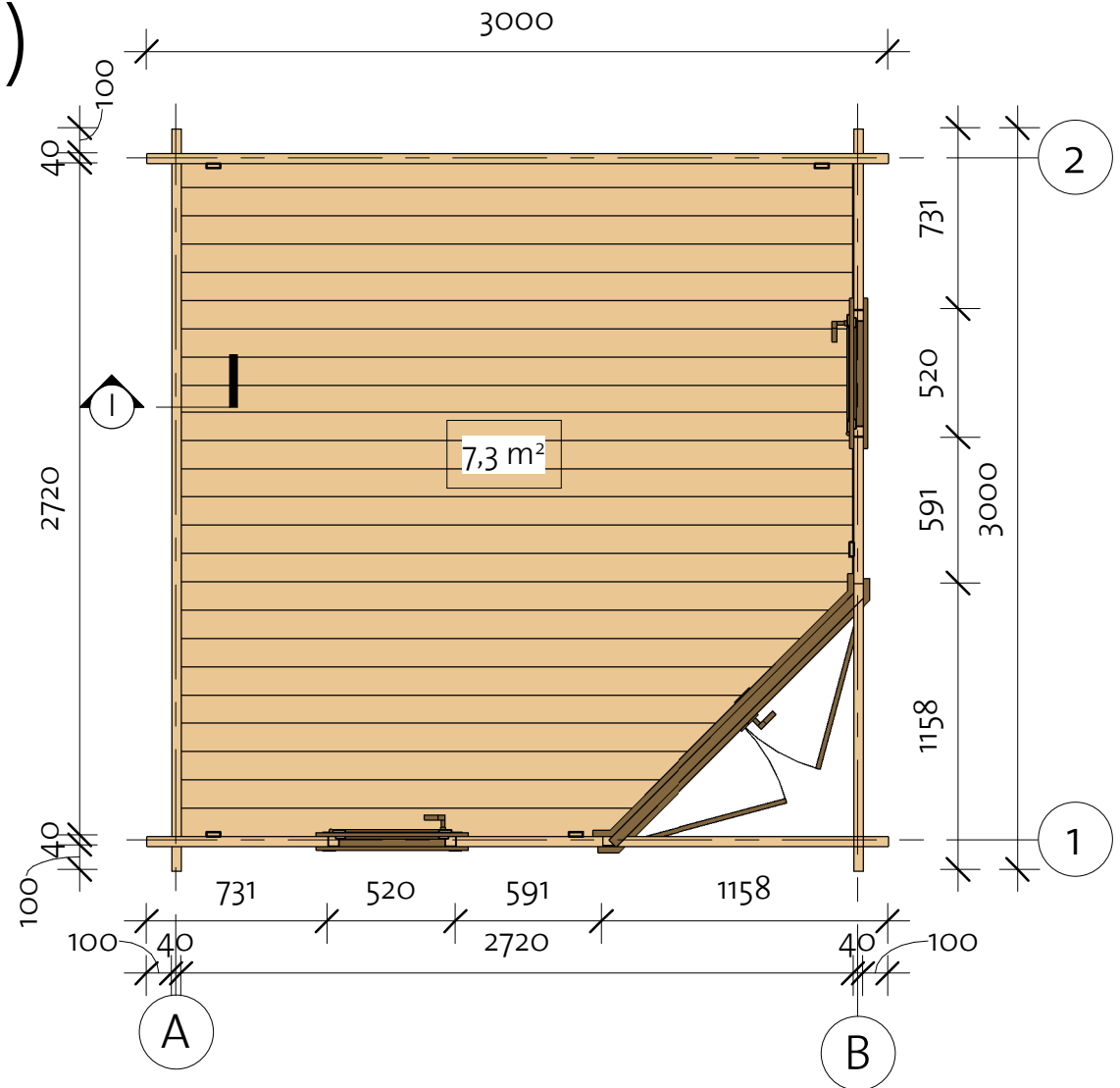

c.Arboga I 40 (280x280)

Wall 1

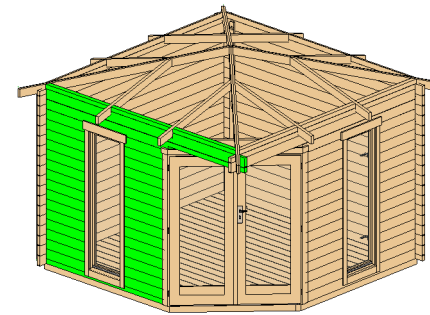

Wall 1			
Mark	Profile	Count	Cut Length

1BL-1	40x57	1	1842
1LG-1	40x114	15	591
1LG-2	40x114	15	731
1LG-3	40x114	1	3000
1LG-4	40x114	1	3000
1TL-1	40x63	1	904
1TL-2	40x63	1	855
1TL-3	40x63	1	904

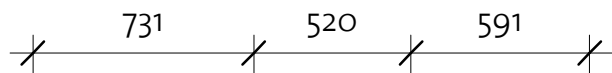
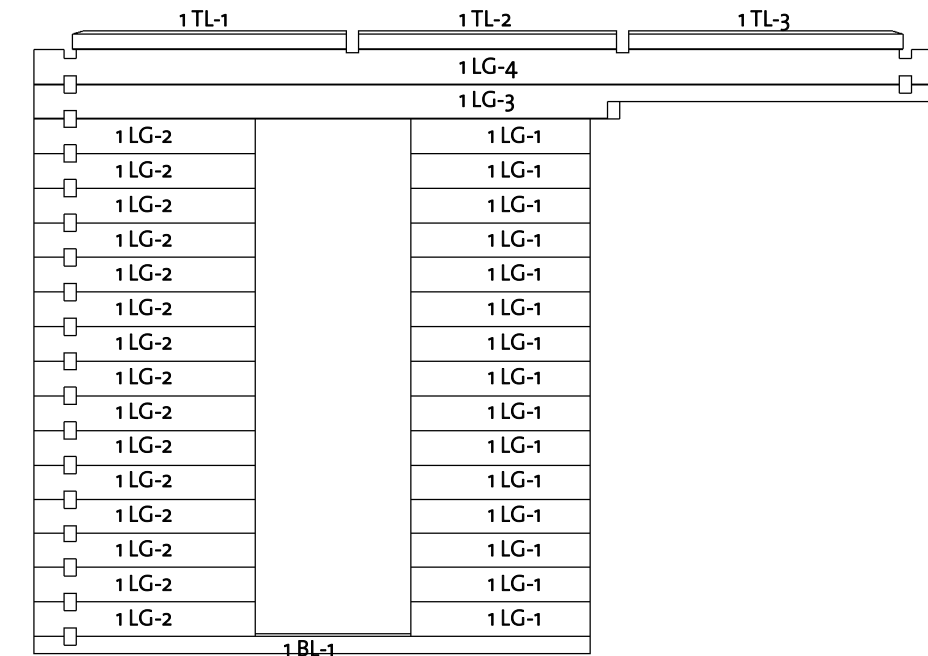

Log Profile Wall 1	
Profile	Profile

40x114	
40x57	

Log Profile Wall 1	
Profile	Profile

40x63	
-------	--

c.Arboga I 40 (280x280)

Wall 2

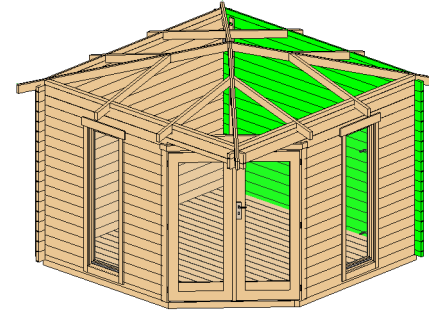

Wall 2			
Mark	Profile	Count	Cut Length

2TL-1	40x63	1	904
2TL-2	40x63	1	855
2TL-3	40x63	1	904
2BL-1	40x57	1	3000
2LG-1	40x114	1	3000
2LG-2	40x114	16	3000

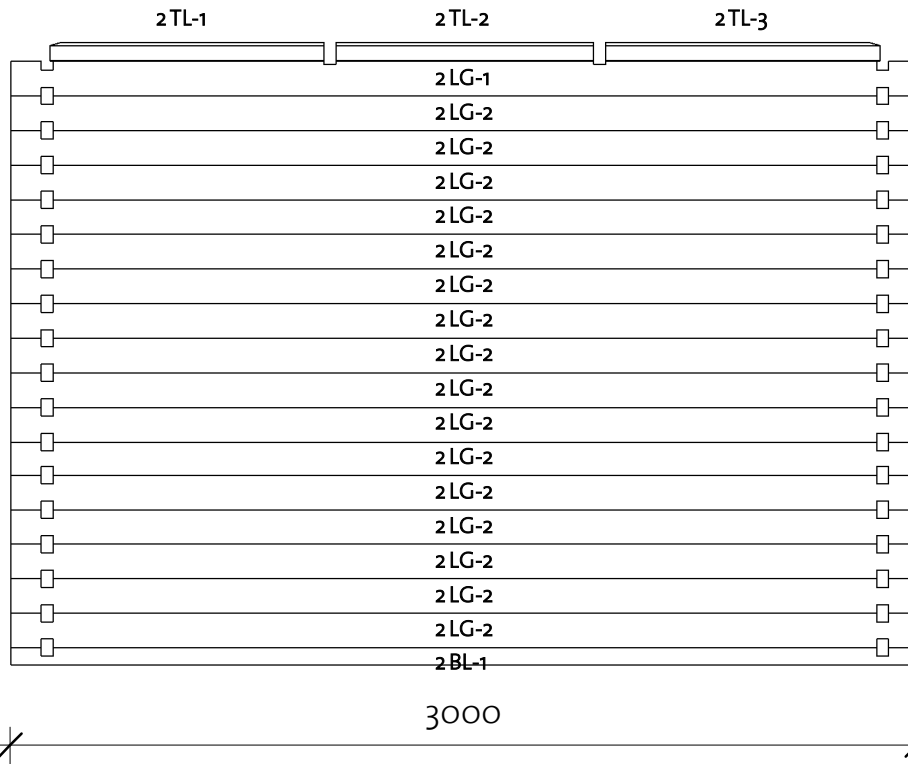

Log Profile Wall 2	
Profile	Profile

40x114	
40x57	

Log Profile Wall 2	
Profile	Profile

40x63	
-------	--

c.Arboga I 40 (280x280)

Wall A

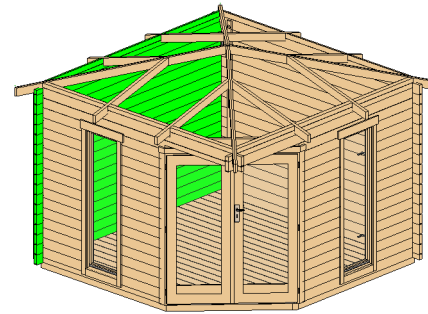

Wall A			
Mark	Profile	Count	Cut Length

ATL-1	40x63	1	904
ATL-2	40x63	1	855
ATL-3	40x63	1	904
ALG-1	40x114	17	3000
ATL-4	40x57 TL	1	3000

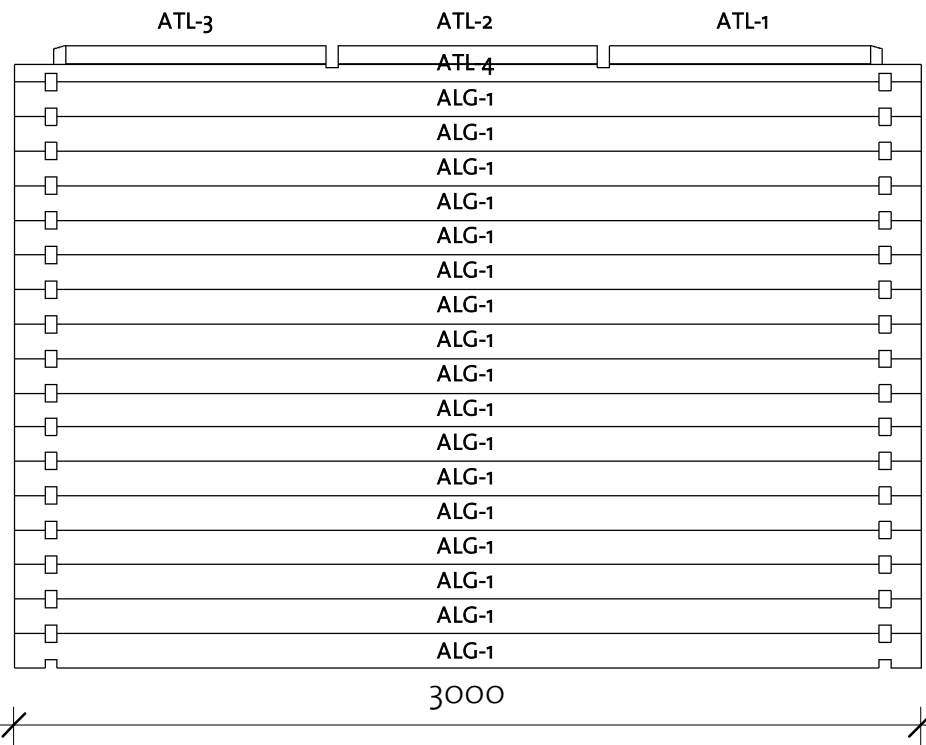

Log Profile Wall A	
Profile	Profile

40x114	
40x57 TL	
40x63	

c.Arboga I 40 (280x280)

Wall B

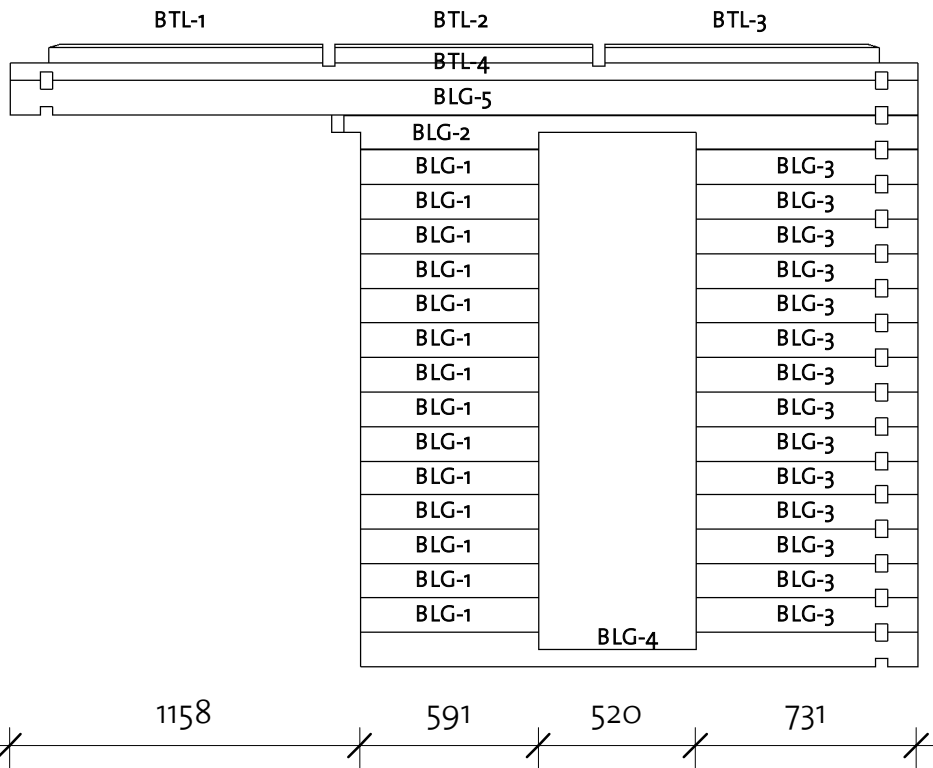
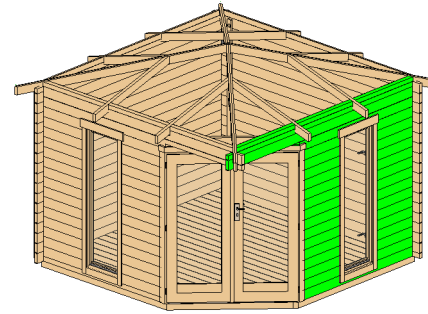

Wall B			
Mark	Profile	Count	Cut Length

BTL-1	40x63	1	904
BTL-2	40x63	1	855
BTL-3	40x63	1	904
BLG-1	40x114	14	591
BLG-2	40x114	1	1938
BLG-3	40x114	14	731
BLG-4	40x114	1	1842
BLG-5	40x114	1	3000
BTL-4	40x57 TL	1	3000

Log Profile Wall B	
Profile	Profile

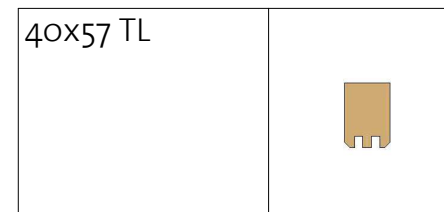

Log Profile Wall B	
Profile	Profile

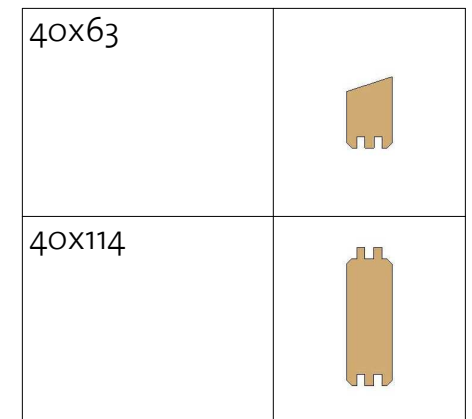

c.Arboga I 40 (280x280)

Roof 1

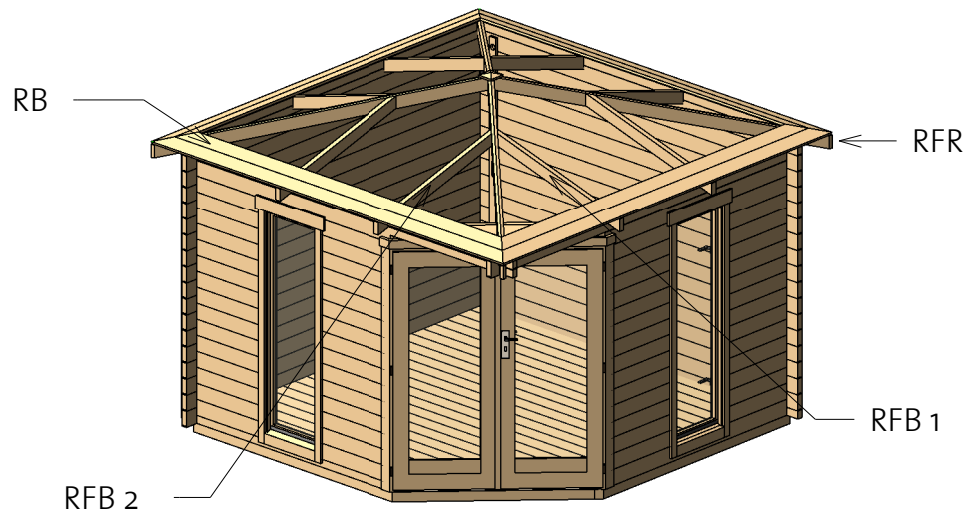

Roof				
Mark	Type	Profile	Count	Length
RFR	40x94		4	2298
RFB1	40x85		4	1208
RFB2	40x85		4	1208

Roofboards				
Mark	Type	Profile	Count	Length
RB1	RoofBoard 17x60		4	117
RB2	RoofBoard 17x114		4	336
RB3	RoofBoard 17x114		4	555
RB4	RoofBoard 17x114		4	774
RB5	RoofBoard 17x114		4	993
RB6	RoofBoard 17x114		4	1212

Roofboards				
Mark	Type	Profile	Count	Length
RB7	RoofBoard 17x114		4	1431
RB8	RoofBoard 17x114		4	1650
RB9	RoofBoard 17x114		4	1869
RB10	RoofBoard 17x114		4	2088
RB11	RoofBoard 17x114		4	2307
RB12	RoofBoard 17x114		4	2526
RB13	RoofBoard 17x114		4	2745
RB14	RoofBoard 17x114		4	2965
RB15	RoofBoard 17x114		4	3184

c.Arboga I 40 (280x280)

Roof 2

Fascia Schedule				
Mark	Type	Profile	Count	Length
RF	Roof Fascia 18x120		4	3204

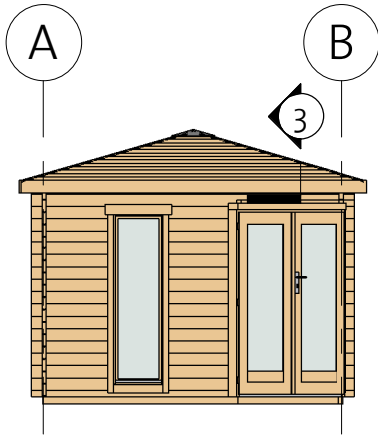

3 Facia

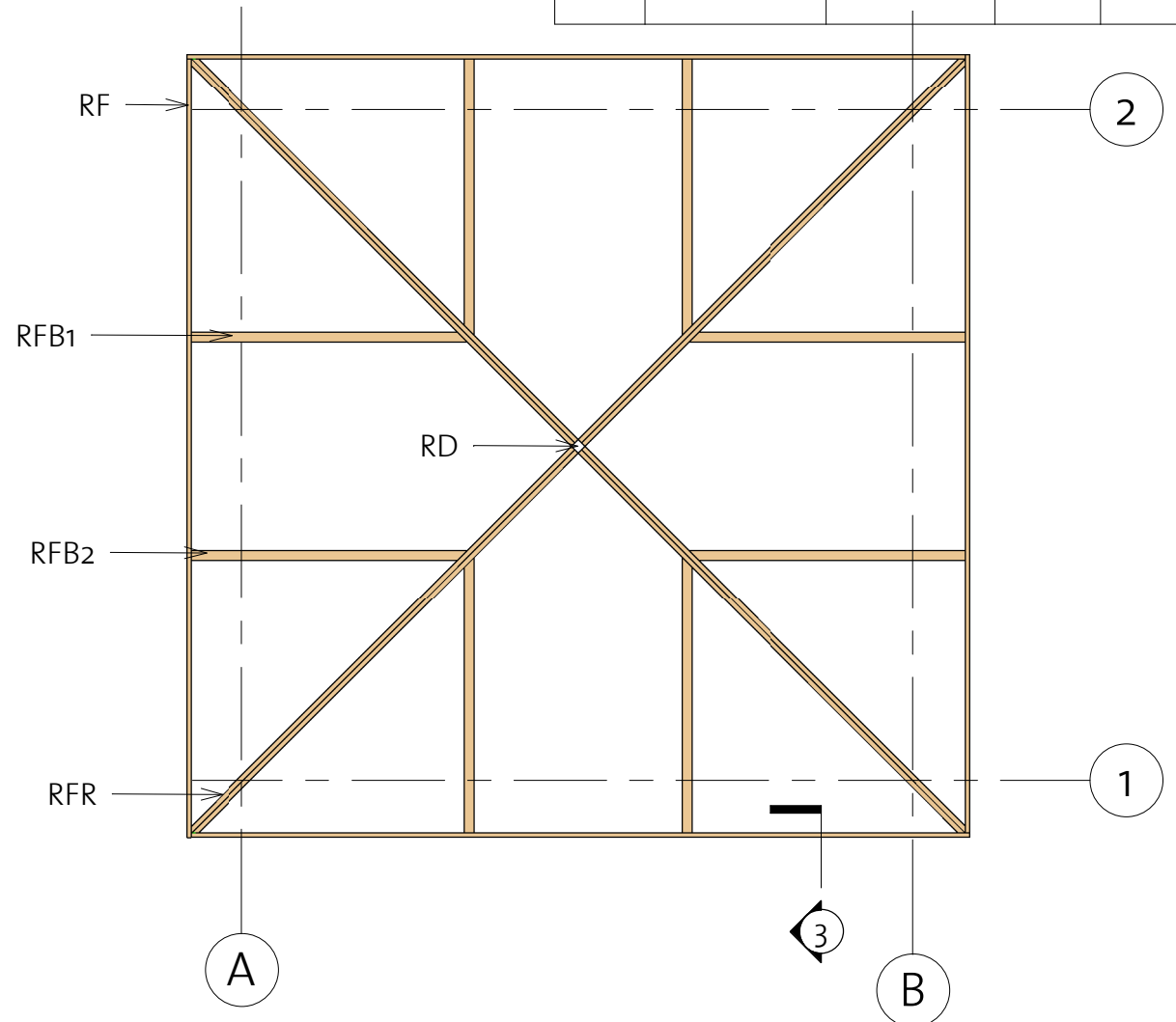
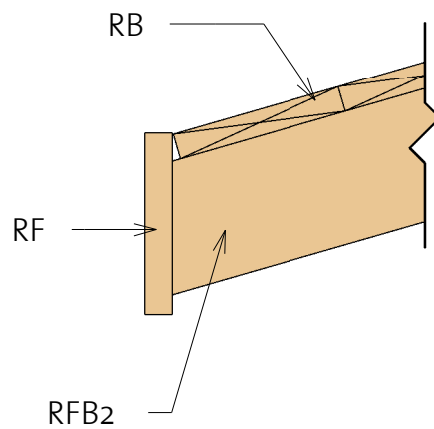

c.Arboga I 40 (280x280)

Extras

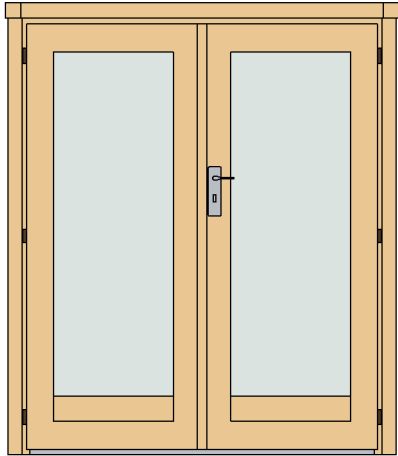

Door Schedule				
Model	Type	Width	Height	Count
CDD13R	Classic double door 13, full glass right	1425	1736	1
DCB8	Door crossbar 8 optional	--	--	2

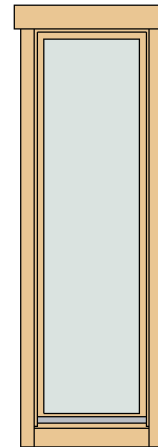

Window Schedule				
Model	Type	Width	Height	Count
CW13R	Classic window 13, full glass right	515	1670	2
WCB8	Window crossbar 8 optional	--	--	2

Fasteners & Extras		
Name	Type	Count

Bolts	M8 x 70	15
Hitblock	300-400 mm	
Nails	1,4 x 40	30
Screws	4,0 x 40	515
Screws	5,0 x 70	50
Screws	6,0 x 140	50



Type	Count	Length
Windboard 18x40	5	2200
Roof Detdail		
Mark	Type	Count
RD	Roof detail	1

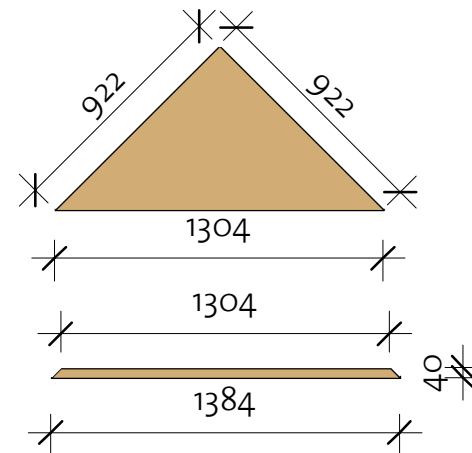

① Roof top 16°

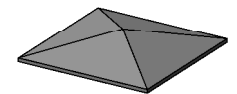

Type	Mark	Count
Ceiling detail 40x120	CD	1
Ceiling triangle	CT	1

- * Windows intended for tilt opening only!
- * Fenster zur Eröffnung nur zum Kippen vorgesehen!
- * Aknad on ette nähtud ainult kaldu avamiseks!

c.Arboga I 40 (280x280)

List of all items 1

Impregnated foundation beams				
Mark	Type	Profile	Count	Length

IFB1	IFB 40x70		6	2750
IFB2	IFB 40x70		1	2224
IFB3	IFB 40x70		1	1845
IFB4	IFB 40x70		1	1805
IFB5	IFB 40x70		2	1376

Floor Schedule				
Mark	Type	Profile	Count	Length

FB1	FB 17x114		1	1847
FB2	FB 17x114		1	1961
FB3	FB 17x114		1	2075
FB4	FB 17x114		1	2189
FB5	FB 17x114		1	2303
FB6	FB 17x114		1	2417
FB7	FB 17x114		1	2531
FB8	FB 17x114		1	2645
FB9	FB 17x114		1	2717
FB10	FB 17x114		16	2717

Roofboards				
Mark	Type	Profile	Count	Length

RB1	RoofBoard 17x60		4	117
RB2	RoofBoard 17x114		4	336
RB3	RoofBoard 17x114		4	555
RB4	RoofBoard 17x114		4	774
RB5	RoofBoard 17x114		4	993
RB6	RoofBoard 17x114		4	1212

Roofboards				
Mark	Type	Profile	Count	Length

RB7	RoofBoard 17x114		4	1431
RB8	RoofBoard 17x114		4	1650
RB9	RoofBoard 17x114		4	1869
RB10	RoofBoard 17x114		4	2088
RB11	RoofBoard 17x114		4	2307
RB12	RoofBoard 17x114		4	2526
RB13	RoofBoard 17x114		4	2745
RB14	RoofBoard 17x114		4	2965
RB15	RoofBoard 17x114		4	3184

BB1	BB 20x40		4	2800
-----	-------------	---	---	------

Fascia Schedule				
Mark	Type	Profile	Count	Length

RF	Roof Fascia 18x120		4	3204
----	-----------------------	---	---	------

c.Arboga I 40 (280x280)

List of all items 2

Wall 1			
Mark	Profile	Count	Cut Length

1BL-1	40x57	1	1842
1LG-1	40x114	15	591
1LG-2	40x114	15	731
1LG-3	40x114	1	3000
1LG-4	40x114	1	3000
1TL-1	40x63	1	904
1TL-2	40x63	1	855
1TL-3	40x63	1	904

Wall 2			
Mark	Profile	Count	Cut Length

2TL-1	40x63	1	904
2TL-2	40x63	1	855
2TL-3	40x63	1	904
2BL-1	40x57	1	3000
2LG-1	40x114	1	3000
2LG-2	40x114	16	3000

Wall A			
Mark	Profile	Count	Cut Length



ATL-1	40x63	1	904
ATL-2	40x63	1	855
ATL-3	40x63	1	904
ALG-1	40x114	17	3000
ATL-4	40x57 TL	1	3000



Wall B			
Mark	Profile	Count	Cut Length

BTL-1	40x63	1	904
BTL-2	40x63	1	855
BTL-3	40x63	1	904
BLG-1	40x114	14	591
BLG-2	40x114	1	1938
BLG-3	40x114	14	731
BLG-4	40x114	1	1842
BLG-5	40x114	1	3000
BTL-4	40x57 TL	1	3000

Log Profiles	
Profile	Profile



Log Profiles	
Profile	Profile

40x114	
40x57	

40x57 TL	
40x63	

c.Arboga I 40 (280x280)

List of all items 3

Roof				
Mark	Type	Profile	Count	Length
RFR	40x94		4	2298
RFB1	40x85		4	1208
RFB2	40x85		4	1208

Windboard

① Windboard Assembly 1



② Windboard Assembly 2

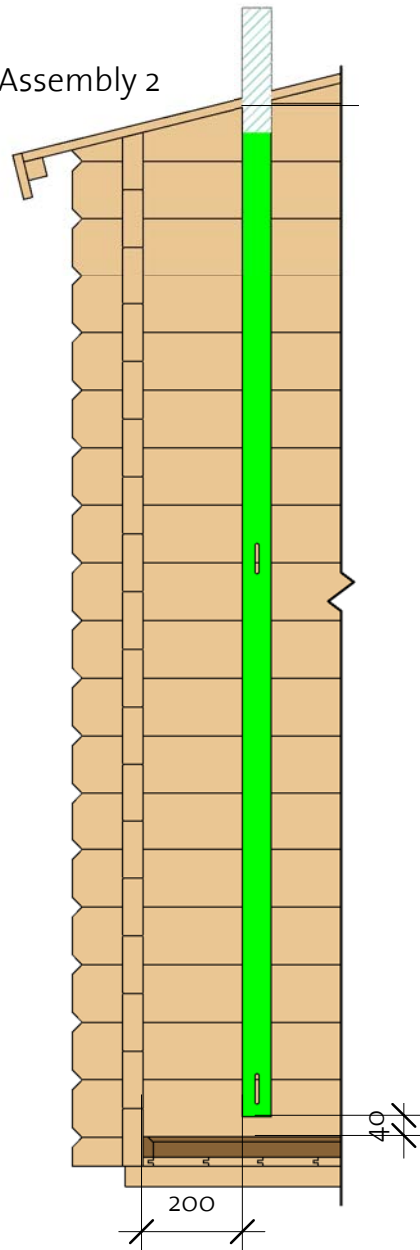

③ Windboard Assembly 3

